

ZENNO

MEGA SS40E 直流無刷管狀馬達系統





關於杉信 | About San Hsin

自1974創立以來，杉信專注於客製化設計及精密製造，是窗簾產業上游主要供應商之一，持續投入開發各式相關產品，追求靜音、省力、耐用的品質，滿足全球各大知名品牌對手動系統及電動系統的需求。



關於 **ZENNO**

ZENNO以直流無刷馬達技術為核心，
提供精準、穩定、低電壓、高相容性的
智能電動遮陽解決方案。我們重視使用者的感受
和施工者的要求，發展出一系列高強度產品，
建立窗簾完美同步齊平新標竿
ZENNO與您一起構築美好合宜的舒適空間

ZENNO



ZENNO

精準 · 堅固 · 靜音 · 環保

全系列產品特色

product feature

精準 - 同步齊平, 定位精準

節能減碳 - 低功耗BLDC直流無刷馬達

應用面廣 - 適用於各種窗簾, 各種場域

大扭力、溫升低 - 適合挑高窗、特大窗工程案件

智慧窗簾解決方案 - 控制介面相容性高, 擴充性強,

容易與樓宇控制系統整合

MEGA



直流無刷管狀馬達系統

BLDC直流無刷馬達，穩定、節能、精準、扭力大靜音馬達，如公園樹葉摩擦聲般輕柔，搭配霍爾感應元件，上下作動均可完美對齊。

應用：捲簾、木百葉、羅馬簾、蜂巢簾、斑馬簾、柔紗簾、投影螢幕

DIANA



電動開合簾

全電壓DC直流馬達，內置式電源供應器、RF接收模組，外觀簡潔俐落。
安裝方式彈性靈活，可直接鎖固軌道於天花板，亦可搭配壁架或天架。

應用：打褶簾、蛇簾、雙開簾、單開簾

ECHO



電動日夜蜂巢簾

BLDC直流無刷馬達，運轉安靜，定位精準，可雙軌同動。
具自動偵測保護功能，避免軌道追撞造成故障。
適用尺寸範圍廣，最小寬度79cm，最大高度400cm，負載尺寸優於業界。

應用：日夜蜂巢簾、TDBU 蜂巢簾



W
E
G
A



ZENNO

精準 · 堅固 · 靜音 · 環保

MEGA SS40E

直流無刷管狀馬達系統

產/品/特/色

BLDC馬達

多窗齊平.定位精準

溫升低.運轉時間長

適合挑高窗

大載重

靜音

RS485 Modbus



MEGA

SS40E

直流無刷管狀馬達系統

- BLDC直流無刷馬達，穩定、節能、精準、扭力大
- 馬達運轉安靜
- 扭力最大可達6Nm，承載26公斤
- 無碳刷，無火花，溫升低，耐久運轉，特別適合挑高窗、特大窗
- 可多窗同動，上下作動均可完美水平對齊，安裝設定省時方便
- 內置全電壓交換式電源、RF模組、乾接點，外觀簡潔俐落
- 具乾接點或RS485介面，可連入中控系統，佈線方便
- 多元操控，可搭配RF遙控、壁控、中控、語音控制、Wifi、APP，靈活彈性相容性高，容易與樓宇控制系統整合
- 台灣製造外銷精品，通過多國安規，品質有保障

適用範圍



捲簾
roller blinds



斑馬簾
zebra blinds

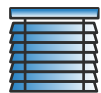

百葉簾
venetian blinds



羅馬簾
roman shades



標準型蜂巢簾
honeycomb shades

為何選擇BLDC馬達?

BLDC直流無刷馬達具有低功耗、扭力大、溫升高、運轉安靜...等多重特點，ZENNO獨步全球將BLDC馬達導入於電動窗簾管狀馬達。

SS40E管狀馬達採用高精度定位技術及多級數減速機，搭配數位演算功能，變頻省電節能環保，優異穩定的輸出扭力、行進速度、控制精度，可克服傳統AC交流感應馬達容易過熱和上下無法齊平的缺陷，並彌補DC馬達扭力偏小的狀況。

SS40E最大扭力6Nm，最大輸入功率僅60W，全載可拉動約26公斤布料，15公斤內可保持定速運轉，讓窗簾上下作動呈現水平對齊，襯托面料質感傳遞視覺美學。

合宜的控制規劃，幫助電動窗簾發揮更高效益

因應智慧建築電動遮陽的需求日趨普及，SS40E提供RF無線遙控、WiFi/APP無線控制、乾接點、RS485等各式控制選擇，乃至於客製化軟硬體服務，以滿足各種場域環境、各式智能系統所需的控制整合。藉由完美合宜的控制管理機制，有助電動遮陽發揮最佳效益，除了具備調節光線、遮陽、保溫、隱私、美觀、便利等功能，進而減少空調、燈光之耗能，為使用者打造智慧節能舒適的活動空間。

窗簾應用

SS40E可應用於多款窗簾，並針對挑高捲簾、雙層捲簾、特大窗木百葉、布梯百葉...等開發專用機構，提供高強度、省力、易安裝的配件。

各簾種載重尺寸極限依面料材質配件而有不同

MEGA

SS40E

直流無刷管狀馬達系統

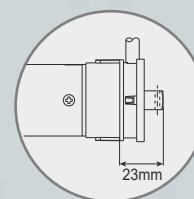
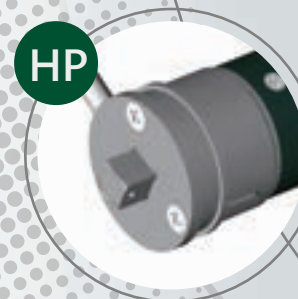
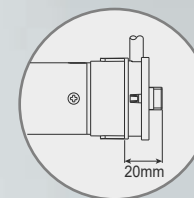
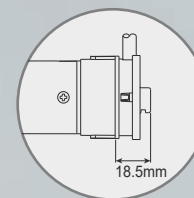
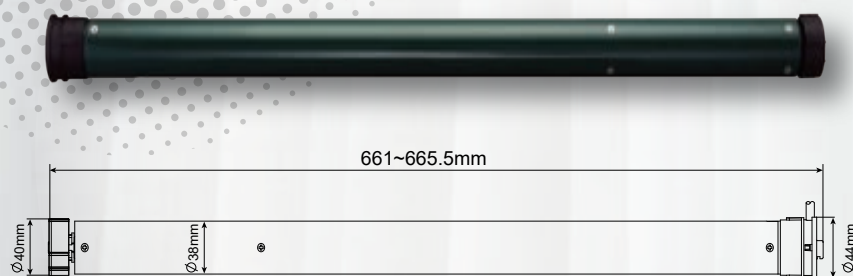

多國安規認證

CE FC



made in Taiwan

MEGA

SS40E

直流無刷管狀馬達系統

馬達種類	尺寸	電源	輸入電壓	輸出電壓	額定功率 最大功率	額定電流	限位方式	溫度保護*	噪音值	防護等級
BLDC 直流 無刷管狀馬達	∅38 x 661 ~ 665.5 mm	內置交換式 電源供應器	100~240VAC 50~60Hz	DC 27V	29W/60W	1A	電子式限位點	75°C	~38 dBA	IP44

* 載重20KG連續運轉30分鐘始達溫度保護點

品名	SS40E-6/22-RF	SS40E-6/22-DCT BASIC	SS40E-5/27-DCT BASIC	SS40EBQ-4/22-DCT BASIC 3K	SS40E-6/22-RS485	SS40E-6/22-UR
品號	79203005X	79203010X	79213010X	79221000X	79203RS0X	79203UR0X
馬達頭	HJ	HJ	HJ	HJ	HJ	HJ
RF無線	433.92MHz	433.92MHz	433.92MHz	433.92MHz	433.92MHz	433.92MHz
外部控制	—	乾接點	乾接點	乾接點	RS485 Modbus	WiFi/APP
扭力/轉速	6Nm/22rpm	6Nm/22rpm	5Nm/27rpm	4Nm/22rpm	6Nm/22rpm	6Nm/22rpm
備註						需搭配專用 Wifi模組

SS40E 產品線種類繁多機種齊全，歡迎洽詢更多產品資訊，亦接受客製化需求

SS40E BLDC 馬達線色定義

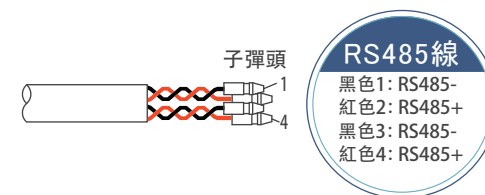
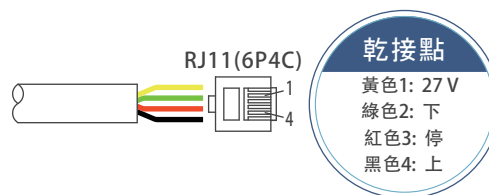
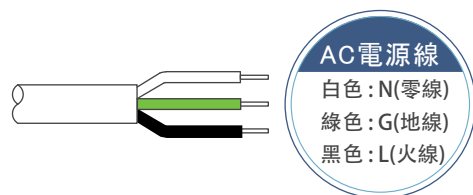

MEGA SS40E

電動捲簾系統



系統特色

- 布料二側漏光最小僅2.95cm, 增添簡約, 質感
- 零件採用降噪材料有效提昇運轉安靜度
- 提供多款高強度托架、配件, 因應案場特殊的安裝環境

鋁管

ATD46
#09501E051

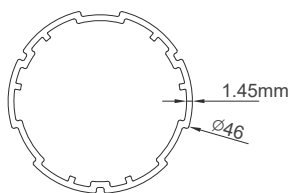

ATD50
#09502E051

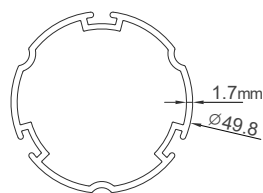

ATD51
#09503E051

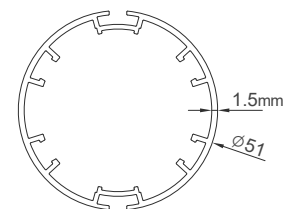

傳動輪

40E 傳動輪
#09501E041

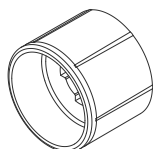

40E DI 傳動輪
#09502E041

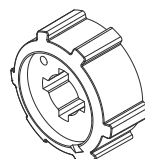

40E 卡榫式傳動輪
#09501E042

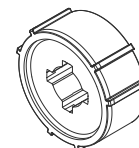

惰輪

ATD46 惰輪組
#49501E011

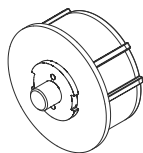

ATD50 惰輪組
#49502E011

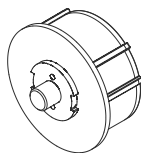

QW46S 快裝式惰輪
#49501E012

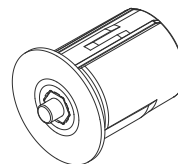

QW50S 快裝式惰輪
#49502E012

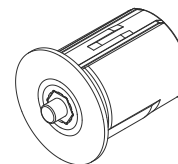

皇冠

ATD50 皇冠
#014006712



ATD51 皇冠
#09503E061

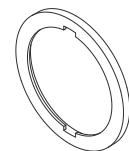

ATD50 DI 皇冠
#09502E062

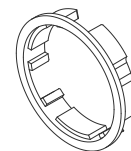

HJ 配件

HJ系列左右漏光最小29.5mm,
托架款式齊全, 適合各種場域
雙窗連結器最小漏光15mm, 安裝便利、對位精準

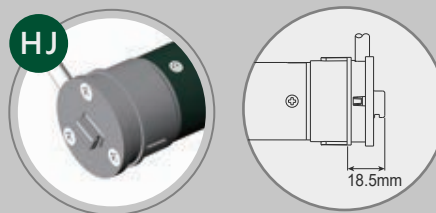

托架組

SBK60
#79501E03X

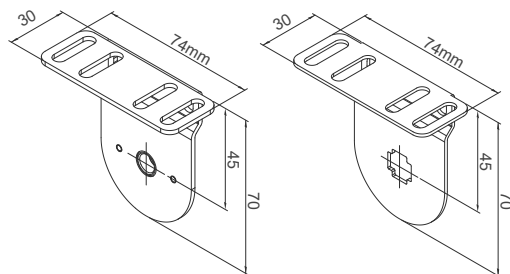

SBK80
#79502E03X

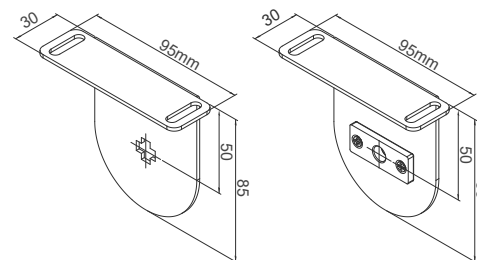

SBK-AD82 可調式托架組
#79503E031

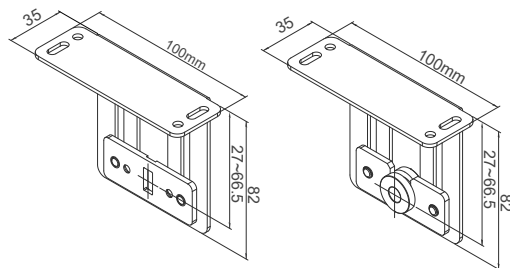

SBK-AD130 可調式托架組
#79503E032

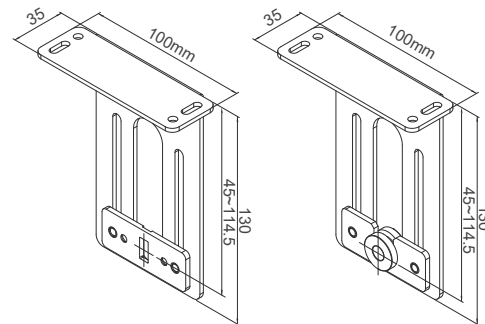

	SBK60 托架組	SBK80 托架組	SBK-AD82 可調式托架組	SBK-AD130 可調式托架組
馬達漏光	19.5mm	18.5mm	22.8mm	23.3mm
惰輪漏光	11mm	11mm	17.4mm	17.5mm
適用高度	3米以內	4米以內	6米以內	9米以內

雙窗連結器

DWC180A-B60
#49506E031

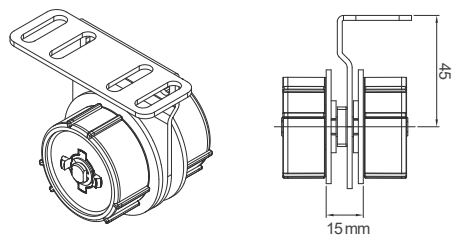

DWC180B-B60
#49506E032

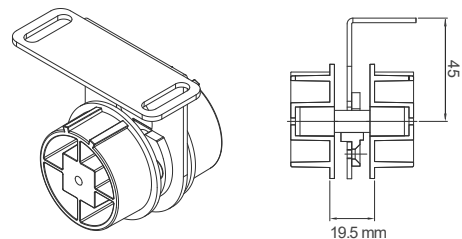

DWC180A-B80
#49506E033

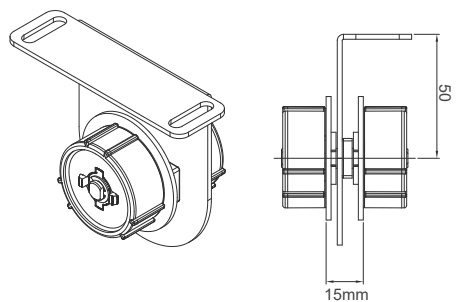

DWC180B-B80
#49506E034

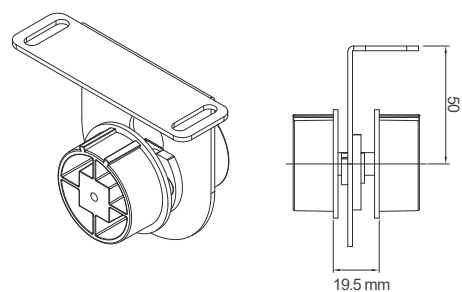

DWC180A-AD82 可調式雙窗連結器
#49506E035

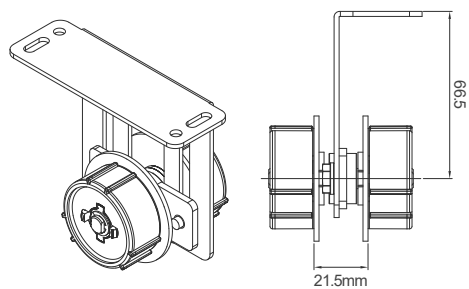

DWC180A-AD130 可調式雙窗連結器
#49506E036

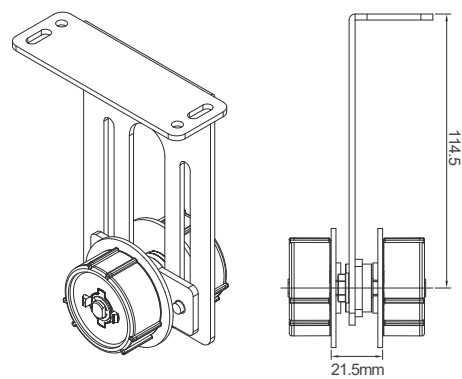

HQ 配件

HQ系列特別為了挑高案場或安裝空間狹小場域而設計，安裝快速，穩固安全
適用於單層捲簾、雙層捲簾
雙層捲簾最大布料直徑90mm

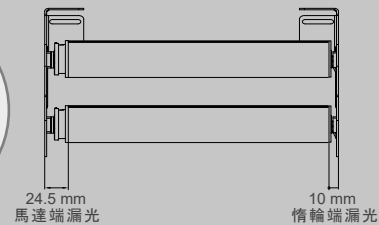
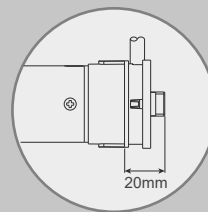
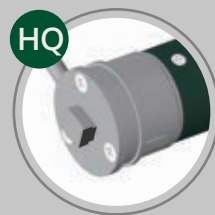

QW單層

托架組
#79512E052

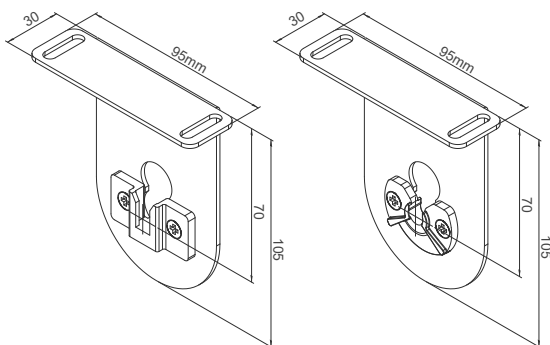

雙窗連結器
#49512E056

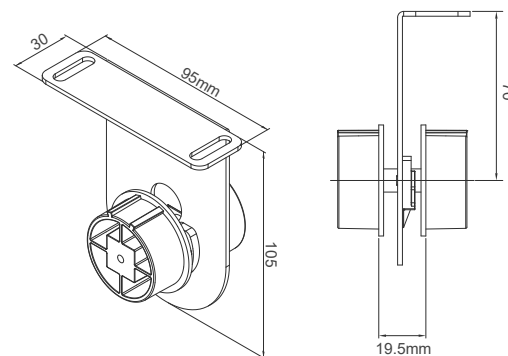

QW雙層

托架組
#79512E051

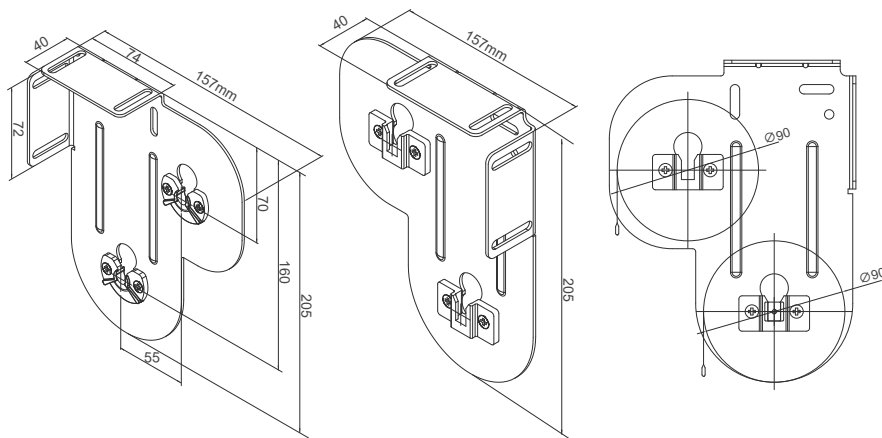

雙窗連結器
#49512E055

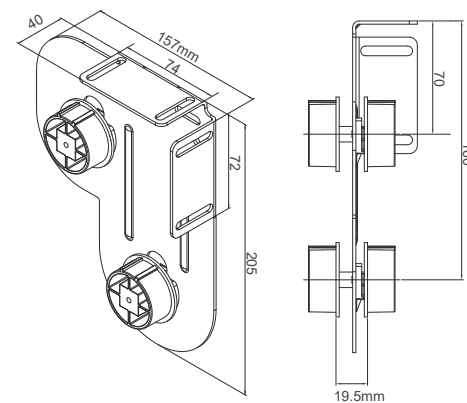

CB鋼索系統

- 利用鋼索減少捲簾布料晃動幅度
- 適用於一般窗、挑高窗、斜窗
- 鋼索可裝設於布料二側或後側位置

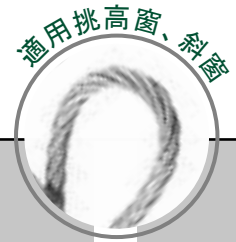

CB-01下軌端蓋
#09807E111

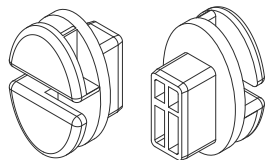

DR-311RH吊環
#09401F14X

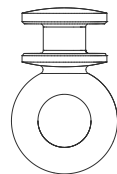

CB-01下軌道(白)
#09807E10X

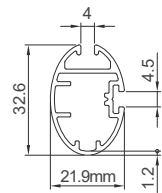
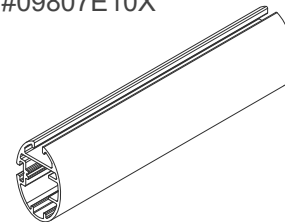

MEGA SS40E

電動斑馬簾系統



系統特色

- 布料最大高度3米
- 併窗行進、調光布料花色齊平，視覺感受舒適美觀
- 可搭配雙窗連結器，漏光僅15mm
- 鋁製歐風上軌道，線條俐落簡約

斑馬簾配件

ZB01上軌道
#09514E071

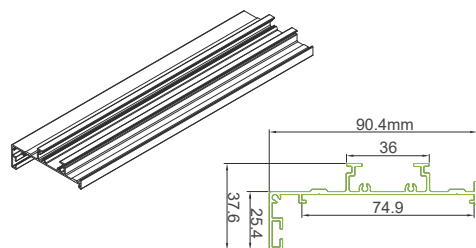

ZB01上軌道前飾板
#09514E072

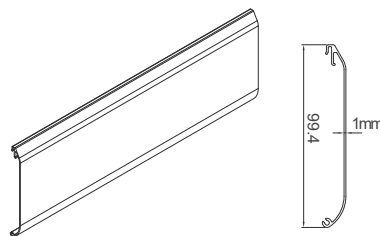

ZB01側封蓋 L
#09514E112

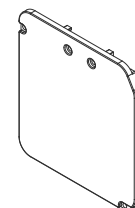

ZB01側封蓋 R
#09514E111

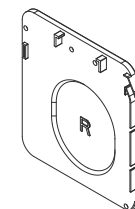

ATD51鋁管
#09503E051

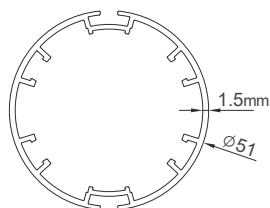

ATD51 皇冠
#09503E061

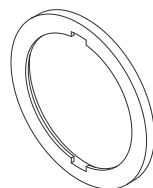

ZB01上軌道掛架
#09505E031

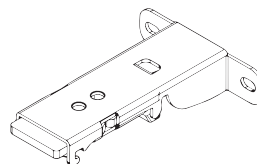

SBK60 托架組
#79501E03X

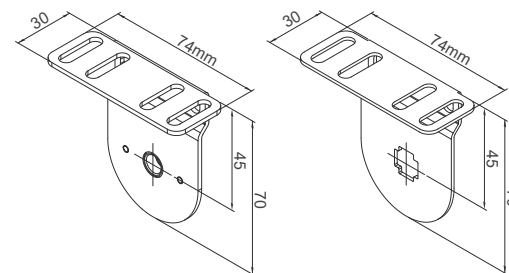

40E卡榫式傳動輪
#09501E042

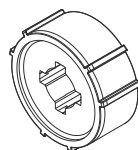

QW50S 快裝式惰輪
#49502E012

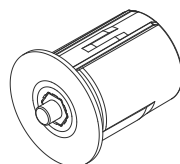

DWC180A-B60 雙窗聯結器
#49506E031

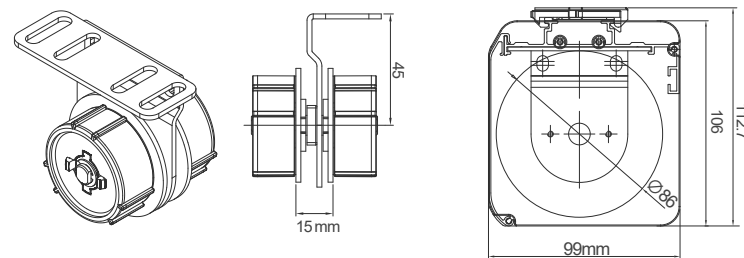

MEGA SS40E

電動標準型蜂巢簾系統

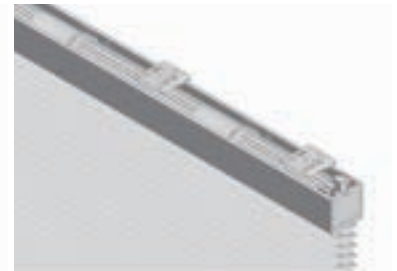
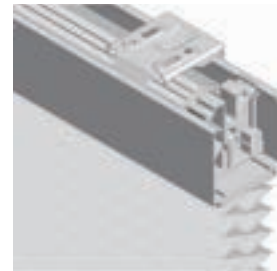

系統特色

- ◆ 最大高度6米
- ◆ 適用於45mm蜂巢簾布料

標準型
蜂巢簾配件

HC60 軌道-白色
#096041091

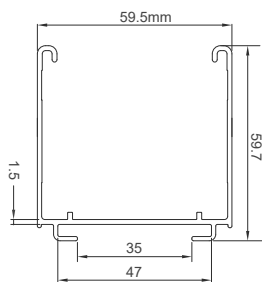

ATO43 八角管
#09602E05X

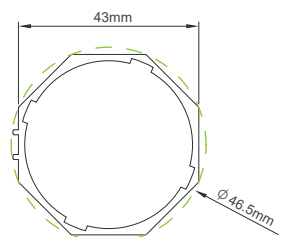

TL 捲線器組-白色
#49602I031

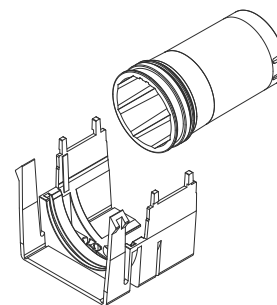

TL 馬達固定架
#09602I07X

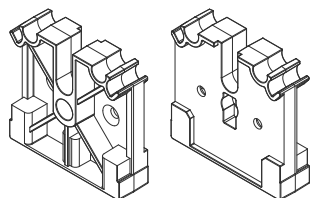

ATO43 傳動輪
#09602E04X

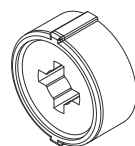

ATO43 惰輪組
#49602E01X

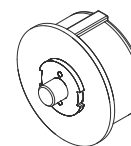

HC60 軌道托架
#49604111X

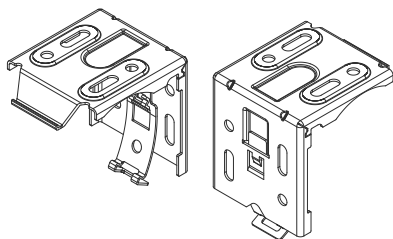

HC60 軌道-白色封蓋
#096041101

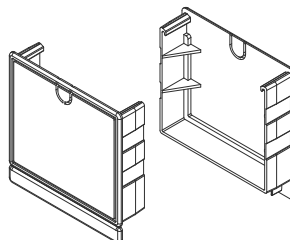

蜂巢上軌及托架

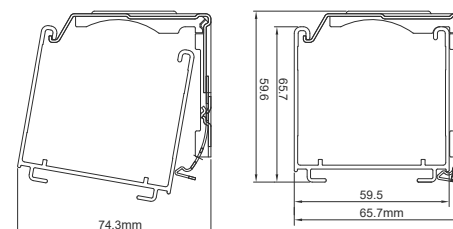



MEGA

SS40E

電動百葉簾系統

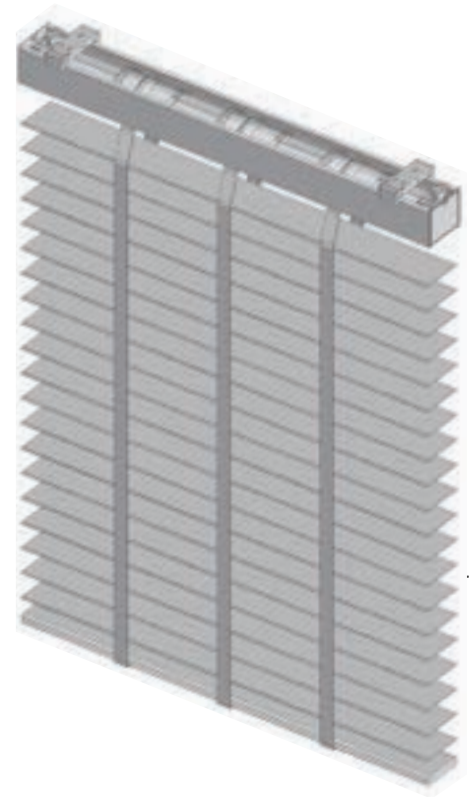

系統特色

- 最大高度5米;最大載重15公斤
- 適用於細梯或布梯
- 專利Quick-fix托架, 強固、安全、便捷, 單人可安裝
- 適合38mm、50mm葉片

SS40E BLDC 電動百葉系統特色

多樣化葉片選擇

SS40E 電動百葉系統適用於38mm及50mm葉片，可搭配各種材質的葉片，包括實木百葉、仿木百葉、鋁百葉、PVC百葉、布百葉...等，並可製做細梯或布梯。

同步齊平

SS40E 電動百葉系統使用單支BLDC變頻馬達做驅動，操作百葉上收下放及吋動翻轉，葉片收放時馬達會自動偵測葉片收疊所產生的重量變化，運轉平穩速度恆定，多窗同時上下作動下擺高度整齊一致，視覺效果美觀舒適。

挑戰挑高大窗

62軌道含托架尺寸小於9 x 9 cm，適合安裝於各種場域，擺脫傳統百葉限制挑戰尺寸極限，最大高度達5米[註1]，最大寬度4.85米[註2]，最大重量15公斤。

[註1] TL細梯捲線器搭配1.8mm拉繩最大高度5米，WL寬梯捲線器搭配1.8mm拉繩最大高度4.8米

[註2] 搭配頂級實木百葉製作而成

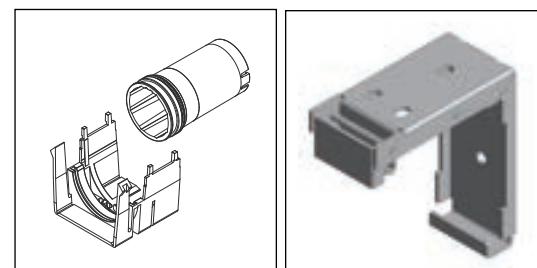

Quick-fix托架

Quick-fix托架專為厚重的百葉所設計，解決挑高大窗電動百葉安裝費力的問題，並確保安裝者及使用者的安全。

(1) 利用倒勾增加支撐的穩固性，可單人進行安裝，亦方便左右調整位置

(2) 前方鎖固扣具可輕鬆押緊，使用細長工具即可翹開

(3) 高強度結構，穩固安全，並減少扣具使用數量

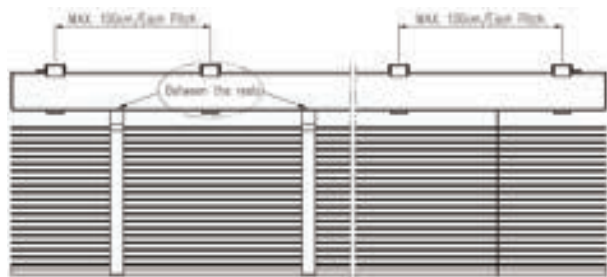

52 細梯百葉配件

52 軌道
#09602I092 (白色)
#09602I091 (核桃木色)

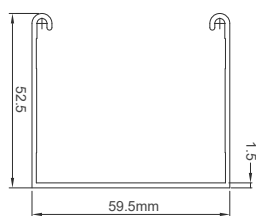

ATO43 八角管
#09602E05X

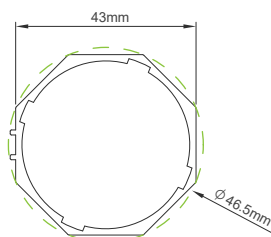

TL 捲線器組
#49602I031 (白色)
#49602I032 (咖啡色)

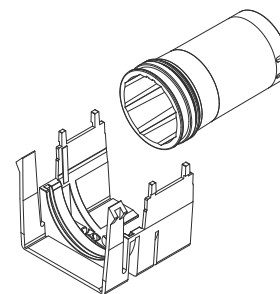

ATO43 傳動輪
#09602E04X

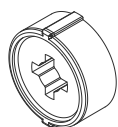

ATO43 惰輪組
#49602E01X

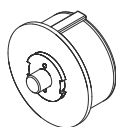

TL 馬達固定架
#09602I07X

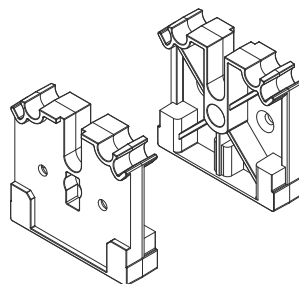

52 上軌道封蓋
#09602I101 (白色)
#09603I102 (咖啡色)

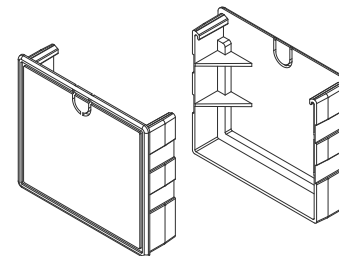

52 軌道 蜘蛛架A
#09602I111

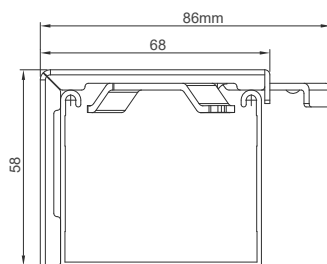
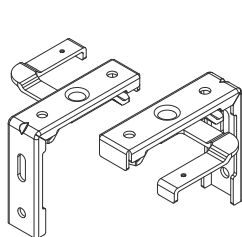

52 上軌輔助支撐板
#779834113 (白色)
#779834114 (咖啡色)

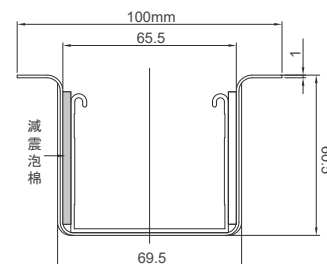
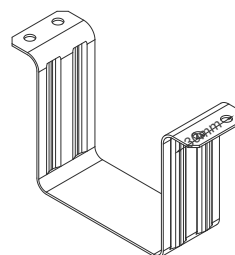

62 細梯/寬梯百葉配件

62 軌道
#09603I092(白色)
#09603I091(核桃木色)

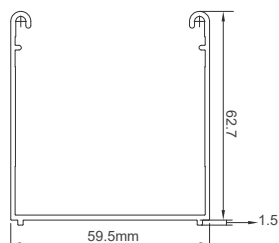

ATO43 八角管
#09602E05X

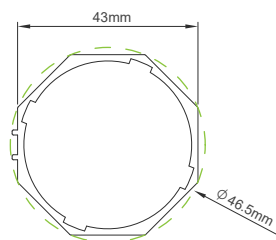

ATO43 傳動輪
#09602E04X

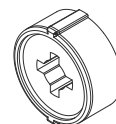

ATO43 惰輪組
#49602E01X

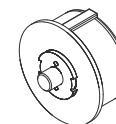

WL 捲線器組
#49603I031(白色)
#49603I032(咖啡色)

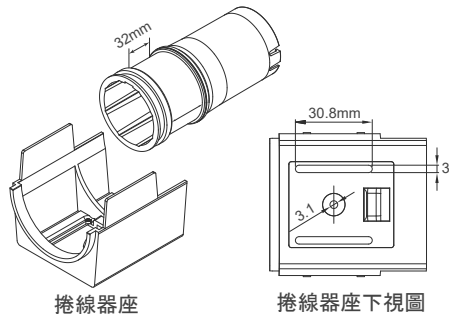

TL 捲線器組
#49602I031(白色)
#49602I032(咖啡色)

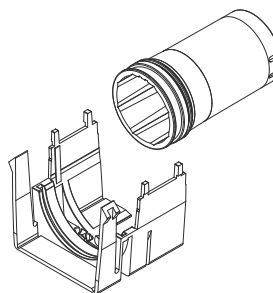

WL 馬達固定架 / TL 馬達固定架
#09603I07X #09602I07X

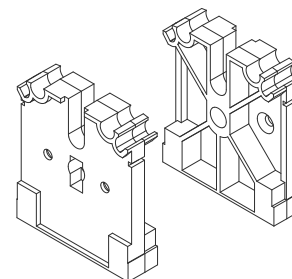

QUICK-FIX 托架
#49603I11X

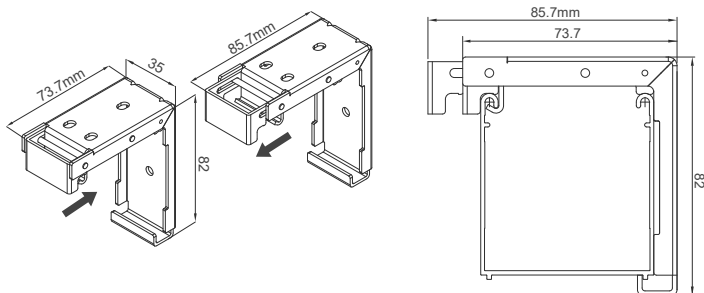

62 上軌道封蓋
#09603I101(白色)
#09603I102(咖啡色)

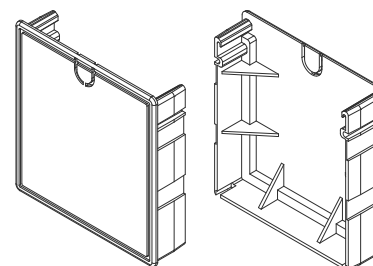



MEGA

SS40E

電動羅馬簾系統

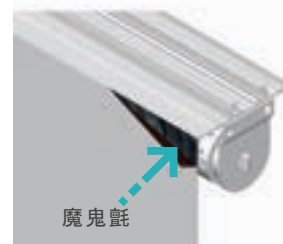

魔鬼氈



羅馬簾配件

ZB01上軌道
#09514E071

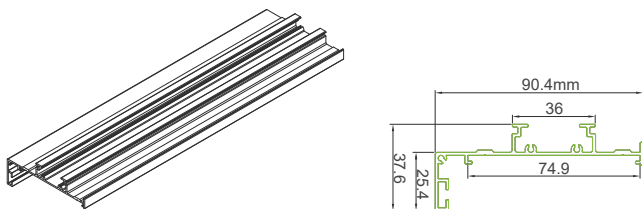

ZB01上軌道掛架
#09505E031

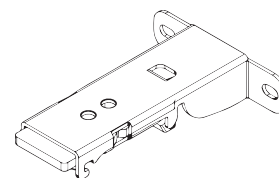

ATD50 鋁管
#09502E051

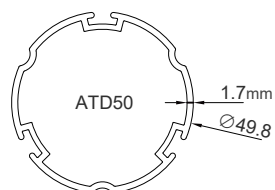

ATD50 皇冠
#09503E061

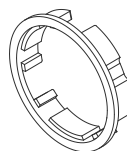

SBK60
#79501E03X

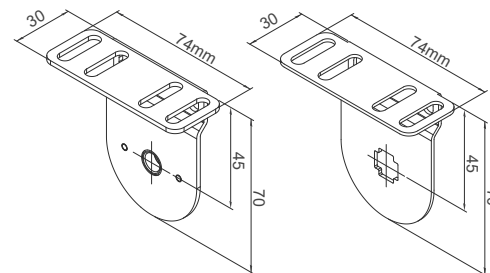

40E 卡榫式傳動輪
#09501E042

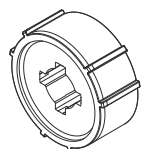

ATD50 惰輪組
#49502E011

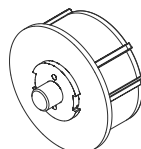

羅馬簾捲線器
#779834001

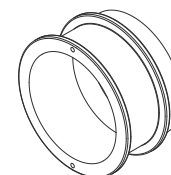

RF遙控器



遙控器型號	SSRC05E		SSRC16C		ZEN16SA	ZEN16DA
顏色	白	黑	白	黑	白	白
頻道	5CH		16CH		16CH	
射頻	433.92 MHz					
最多編碼數	16 millions					
有效距離	30 ~ 100 meters				30 ~ 85 meters	
電池	CR2032 x 1				CR2032 x 2	
尺寸	45.5 x 125.5 x 14 mm				50 x 155 x 16 mm	
功能	上、下、停、吋動、喜好點、複製、群控、總控					
適用機種	SS25E、SS40E、SC50				EHC-120 SS25E、SS40E、SC50	
其他	壁掛架收納 · NCC.FCC認證					



ZENNO

WIFI 智慧窗簾

當家庭設備連上網路後，即變成了智能網中的一部分。透過智慧手機、APP介面、智慧音箱來完成遠端操控智慧窗簾、智慧門鎖、智慧家電，讓你的居家更便利。

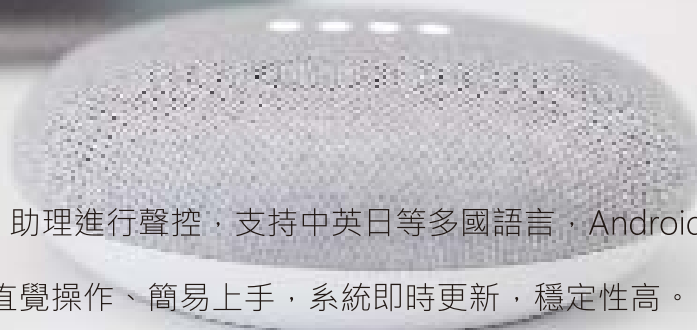
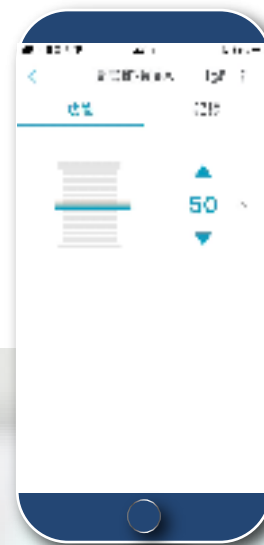

智慧聲控 可透過智慧音箱或 Google 助理進行聲控，支持中英日等多國語言，Android、iOS 手機皆適用。

簡易設定 使用 Google 原生系統，直覺操作、簡易上手，系統即時更新，穩定性高。

情境模式 隨心設定個人化情境模式，「打開窗簾一點點」、「關閉捲簾百分之 30」、「早安」、「晚安」等。

資安保障 金融等級加密技術，提供強大資安保障。獨家專利連線技術，無需另購閘道器，直接連結 Wifi 即可。

ZENNO 電動窗簾群組控制解決方案

ZONEX 1 輕巧便利的模組化設計，提供窗簾控制網絡多元的配置選擇，透過 **ZONEX 1** 可連接多支SS40E 乾接點馬達，形成一個或數個控制群組，藉由壁控開關或Relay型設備進行窗簾的群組控制或單獨控制。採用標準通訊接口，安裝簡便，佈線單純，訊號穩定，大幅節省安裝設定及維護保養的成本，可同時配置單控及群控。



SS40E-DCT 乾接點馬達應用



- ▶ 馬達內置乾接點模組，提供帶RJ11接頭之乾接點訊號線(6P4C)，可與壁控開關及Relay型開關設備對接，
- ▶ 可搭配2鍵式或3鍵式壁控開關控制馬達，操作吋動、開、停、關
- ▶ 可搭配 **ZONEX 1** 群組控制器，進行馬達各別控制或分區、分群的控制，最高可推動200台設備
- ▶ 每個 **ZONEX 1** 至多推動5支馬達

部件介紹



RJ11

連接 ① 壁控 (單獨控制對側RJ11埠所連接的馬達)
或 ② 馬達



RJ45

連接 ① 壁控 (群組控制)
② 下一個ZONEX 1



Vin:24V

連接DC24V電源

接頭及腳位定義:

歐規端子5.08mm



1 GND
2 24V

RJ11 (6P4C)



1 X
2 COM
3 DOWN
4 STOP
5 UP
6 X

RJ45(8P8C)



1 X
2 X
3 24V
4 DOWN
5 STOP
6 UP
7 GND
8 X

Vin:24V

RJ45

RJ11
(6P4C)

RJ45

RJ11
(6P4C)

ZONEX 1 群組控制器產品規格

輸入電壓	24 VDC
輸入電流	1 A (可依實際需求選用更高規格)
待機電流	0 mA
操作電流	11.4 mA
最大馬達串接數	5支馬達
最大連結數	100個 ZONEX 1
最大負載數	200個設備 (馬達及壁控)
尺寸	45.5 *44 *24.7 mm
工作溫度	-20°C ~ +55°C



用壁控操作同一控制迴路內全數電動窗簾(群控)，
上下一起同時動作；並可另接壁控單獨操作某一窗。

所需配件：SS40E-DCT BASIC馬達、ZONEX 1群組控制器、DC24V電源供應器、壁控開關

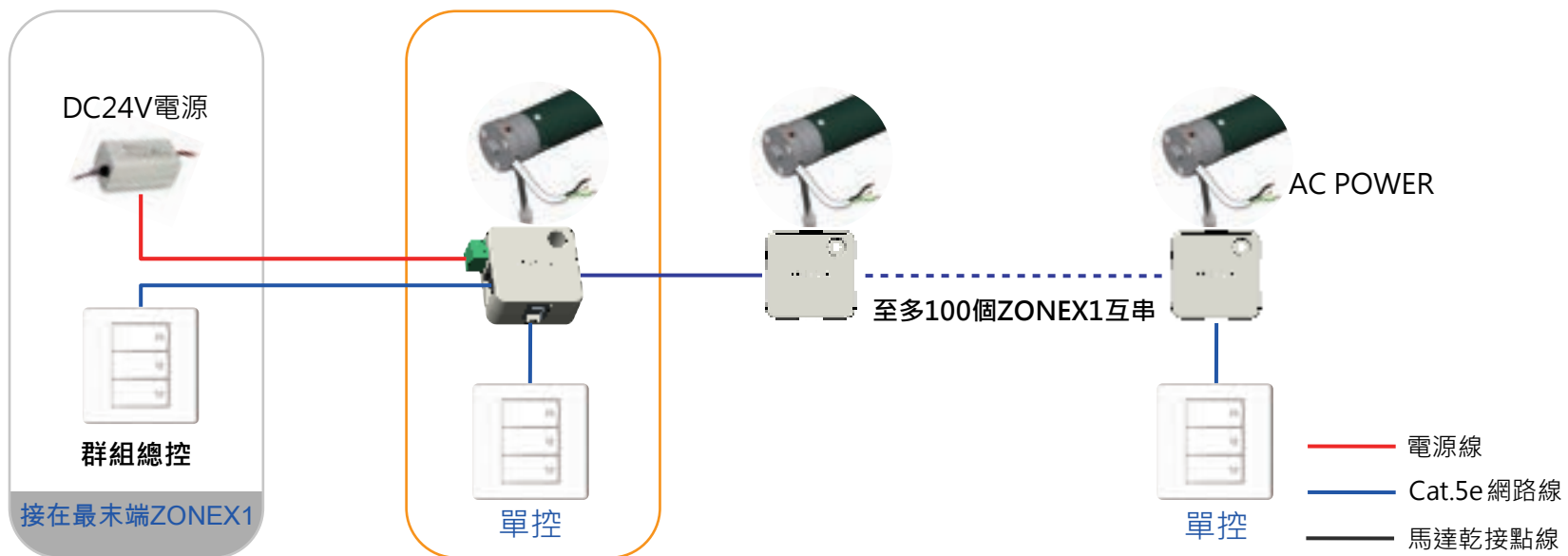



窗簾分為多區控制迴路，可將多區併為一個群組，用壁控操作群組內全數電動窗簾，同時一起上下動作；亦可另接壁控單獨操作某一區。

所需配件：SS40E-DCT BASIC馬達、ZONEX 1群組控制器、DC24V電源供應器、壁控開關、三通接頭

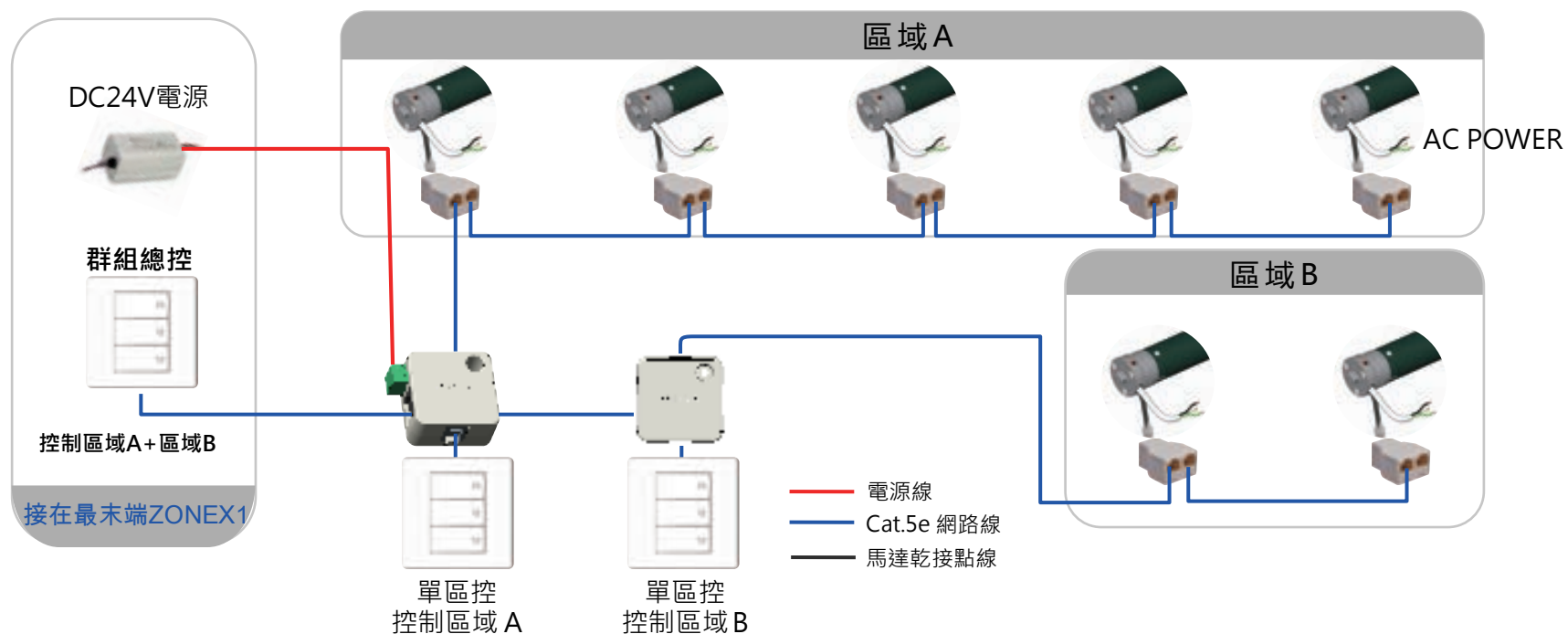



杉信實業股份有限公司
SAN HSIN PLASTECH CO., LTD.

Tel : + 886-3-364-7566 Website : www.sanhsin.com.tw
Fax : + 886-3-364-7752 E-mail : motor.sector@sanhsin.com.tw
SS40E CATALOG 2022-V1