

ZENNO

MOTORIZATION SYSTEM

DATABOOK

DIANA 電動開合簾系統

DIANA MOTORIZED CURTAIN SYSTEM

Version : 2020-V4

目錄 CONTENTS

SC50 開合簾馬達 SC50 CURTAIN MOTOR	3~4
RF 遙控器 RF REMOTE CONTROL	5
DK30 電動藝術軌開合簾系統配件 DK30 MOTORIZED DECORATIVE CURTAIN RAIL SYSTEM PARTS	6~8
DN31 電動開合簾系統配件 DN31 MOTORIZED CURTAIN RAIL SYSTEM PARTS	9~11

SC50 開合簾馬達

SC50 CURTAIN MOTOR

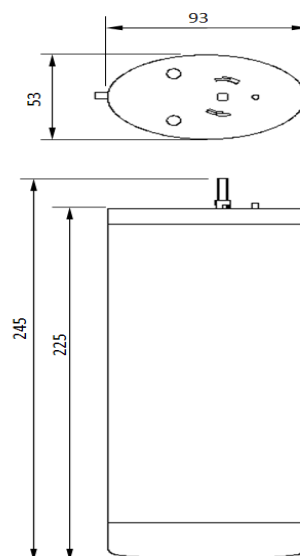

產品規格 Product Specifications

型號 Model Number	SC50
品號 Product number	49401A00X
輸入電壓 Input voltage	100~240VAC 50~60Hz
輸出電壓 Output voltage	DC 24V
扭力 Torque	1 Nm
額定轉速 Rated speed	105 rpm +/- 5 rpm
連續運轉時間 Max. running time in one direction	2.5 mins
產品尺寸 Dimension	245 x 93 x 53 mm
外部控制方式 External control	乾接點 Dry contact
無線射頻 Radio frequency	Built-in 433.92MHz
防護等級 Protection class	IP30
噪音值 Noise level	42dB (A)
應用範圍 Applications	布簾 curtain
安規認證 Certifications	CE、CB

◆ 馬達配線 Motor Wiring

➤ AC 電源線接線 AC Power Wiring

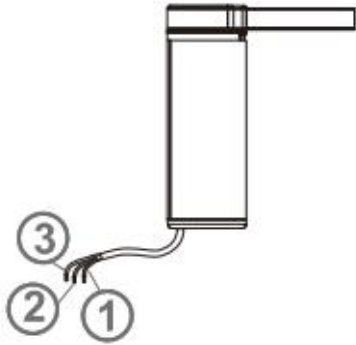

	電線 Wire	100V~240V
1	中性線 Neutral	藍 Blue
2	火線 Live	棕 Brown
3	地線 Earth	黃綠 Yellow/Green

➤ 乾接點接線 DCT Wiring

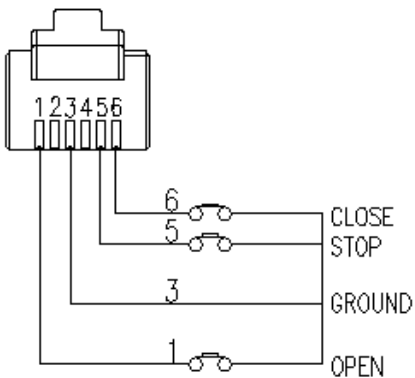

Pin	顏色 Colors	功能 Function
1	白 White	正轉/開 CCW /OPEN
2	黑 Black	X
3	紅 Red	共點 COMMON
4	綠 Green	X
5	黃 Yellow	停止 Stop
6	藍 Blue	反轉/關 CW /CLOSE

RF 遙控器

RF REMOTE CONTROL



產品規格 Product Specifications

型號 Model No.	SSRC05E		SSRC16C	
控制頻道 Channel	5ch		16ch	
無線射頻 Radio frequency	433.92 MHz			
滾碼數 Max. codes	1600 million			
功能 Functions	上,下,停,吋動,喜好點 Up, down, stop, inch shift, preferred position			
有效距離 Effective range	30 ~ 100 M			
顏色 Colors	白 White	黑 Black	白 White	黑 Black
品號 Product No.	779821003	779821002	779821103	779821102

DK30 電動藝術軌開合簾系統



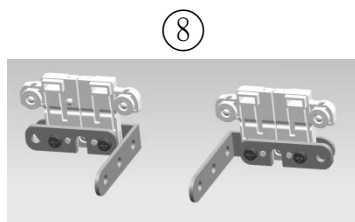
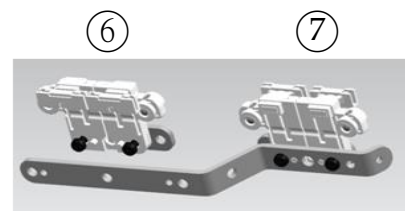
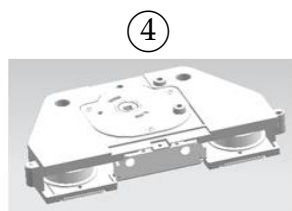
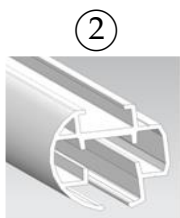
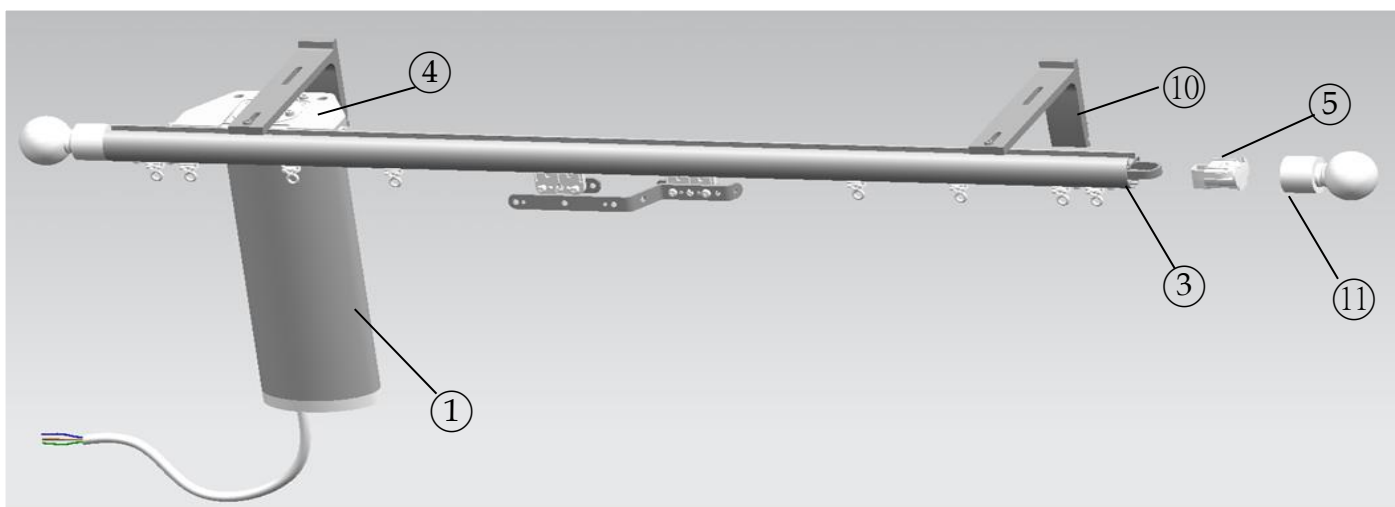

DK30 MOTORIZED DECORATIVE CURTAIN RAIL SYSTEM

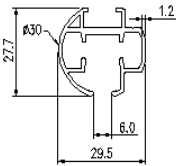
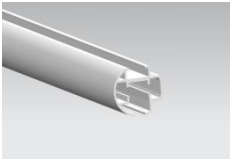
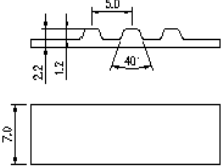

No.	中文品名	Product Name
1	SC50 開合簾馬達	SC50 CURTAIN MOTOR
2	DK30 藝術軌道	DK30 DECORATIVE RAIL
3	時規皮帶	BELT
4	DK30 主傳動箱組	DK30 GEARBOX
5	DK30 副傳動箱組	DK30 SUB-GEARBOX
6~8	DKM MASTER CARRIER	DKM MASTER CARRIER
9	滑輪組	RUNNER
10	DK30 支架組	DK30 BRACKET
11	軌道飾頭	FINIAL

DK30 電動藝術軌開合簾系統配件

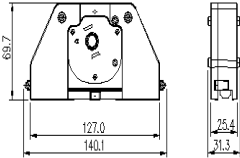
DK30 MOTORIZED DECORATIVE CURTAIN RAIL SYSTEM PARTS

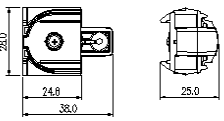
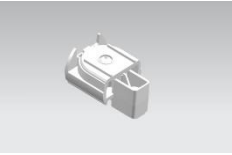
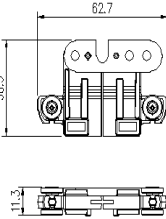
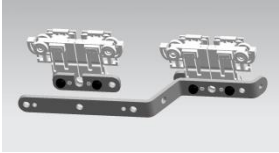
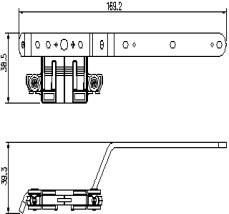
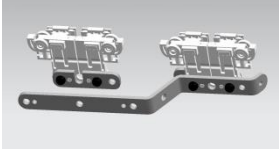
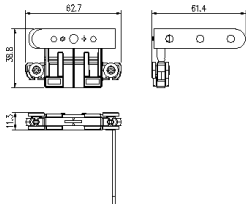
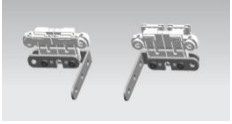
<p>DK30 藝術軌道 DK30 decorative rail 鋁本色 nature silver</p> <p>#09401F011</p>		
<p>T5 時規皮帶, 7mm T5 belt, 7mm</p> <p>#09401F02X</p>		
<p>DK30 主傳動箱組 DK30 gearbox</p> <p>#49401F05X</p>		
<p>DK30 副傳動箱組 DK30 sub-gearbox</p> <p>#49401F09X</p>		
<p>DKM3050 master carrier 短臂 DKM3050 master carrier short arm</p> <p>#49401F111</p>		
<p>DKM3170 master carrier 長臂 DKM3170 master carrier long arm</p> <p>#49401F112</p>		
<p>DKM3090 butt master carrier</p> <p>#49401F113</p>		

DN31 電動開合簾系統

DN31 MOTORIZED CURTAIN RAIL SYSTEM

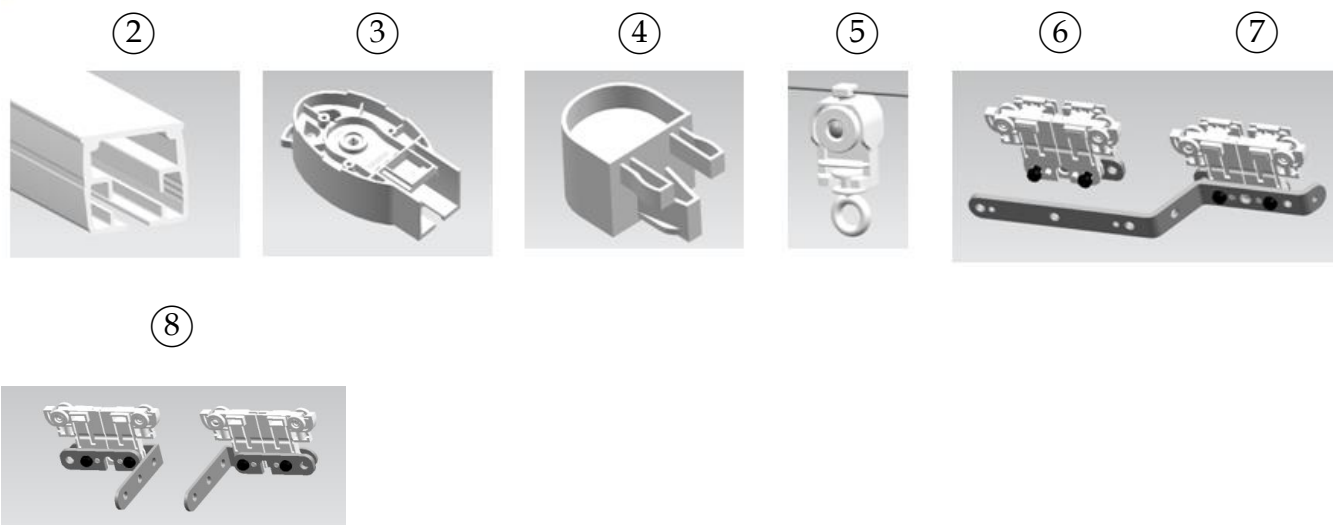
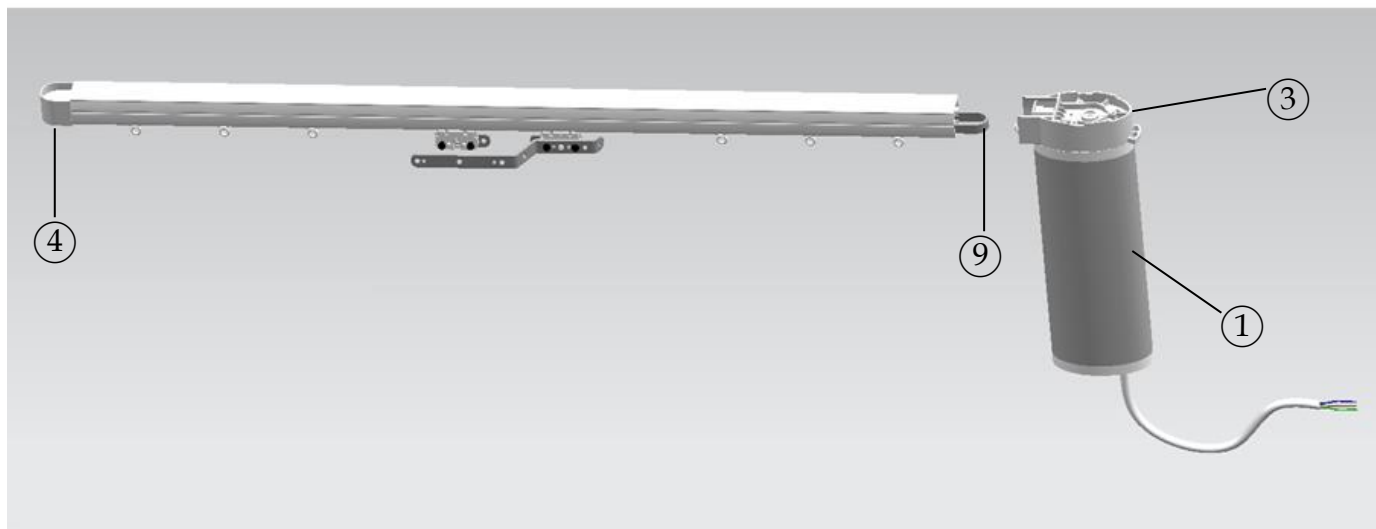





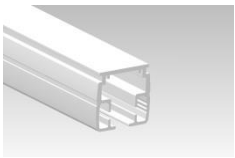
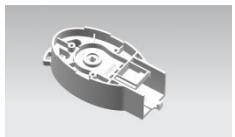
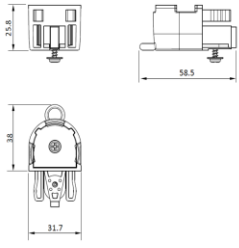
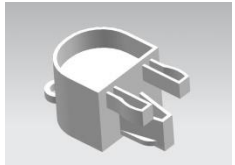
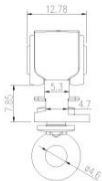
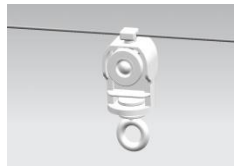
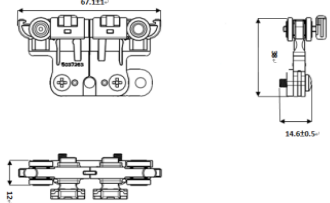
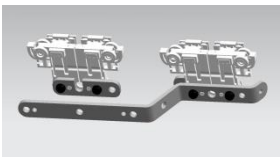

No.	中文品名	Product Name
1	SC50 開合簾馬達	SC50 CURTAIN MOTOR
2	DN31 普通軌軌道	DN31 CURTAIN RAIL
3	DN30 主傳動箱組	DN30 GEARBOX
4	DN30 副傳動箱組	DN30 SUB-GEARBOX
5	滑輪組	RUNNER
6~8	DNM MASTER CARRIER	DNM MASTER CARRIER
9	時規皮帶	BELT

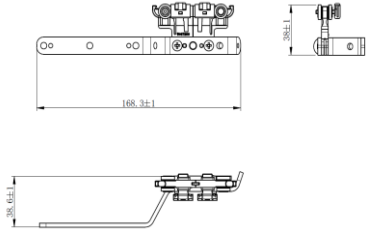
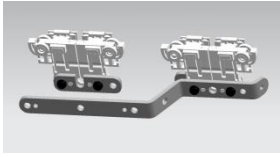
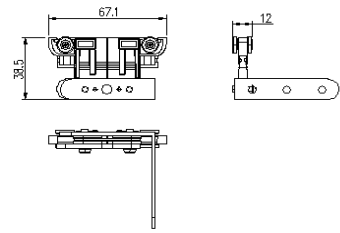
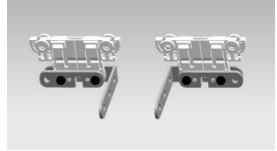
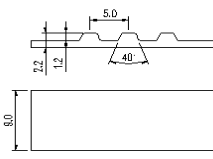
DN31 電動開合簾系統配件

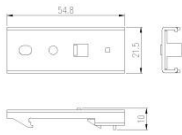
DN31 MOTORIZED CURTAIN RAIL SYSTEM PARTS

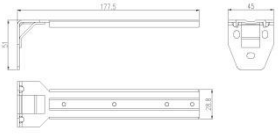
<p>DN31 軌道 DN31 rail 白色 white</p> <p>#09405F011</p>		
<p>DN30 主傳動箱組 DN30 gearbox</p> <p>#09402F05X</p>		
<p>DN30 副傳動箱組 DN30 sub-gearbox</p> <p>#09402F09X</p>		
<p>DR-314RH 靜音滑輪組_3.5kg DR-314RH quiet runner_ 3.5kg</p> <p>#49408F041</p>		
<p>DL-S80 調距帶 DL-S80 link cord</p> <p>#09401F13X</p> <p>DL-S60 調距帶 DL-S60 link cord</p> <p>#09405F13X</p>		
<p>DNM3050 master carrier 短臂 DNM3050 master carrier short arm</p> <p>#09402F111</p>		

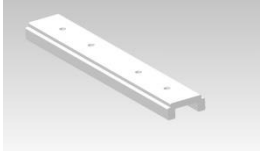
<p>DNM3170 master carrier 長臂 DNM3170 master carrier long arm</p> <p>#09402F112</p>		
<p>DNM3090 butt master carrier</p> <p>#49402F11X</p>		
<p>T5 時規皮帶 9mm T5 belt 9mm</p> <p>#09402F02X</p>		
<p>DN31 鎖天掛架 DN31 ceiling mount bracket</p> <p>#09405F12X</p>		
<p>DN31 鎖壁掛架 DN31 wall mount bracket</p> <p>#09408F12X</p>		
<p>DN31 軌道連結片 DN31 rail joiner</p> <p>#09405F15X</p>		

DN31 托架尺寸 安裝說明

